

**wavin** **OSMA**

# Hep<sub>v</sub>O Hygienic Self-Sealing Waste Valve



# Hygienic Self-Sealing Waste Valve

## OSMA Hep<sub>v</sub>O

It won't dry out! It won't gurgle!  
It won't let you down...

Silent operation,  
no gurgling.

Hep<sub>v</sub>O hygienic  
self-sealing  
waste valve.

Elastomeric membrane  
prevents foul sewer air  
from entering the building.

Connects to 1¼"  
and 1½" BSP thread.

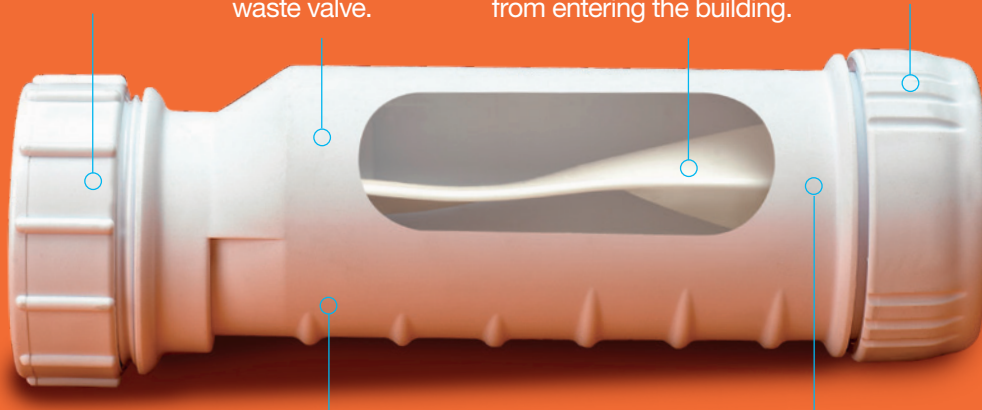

ATS 5200-047:2005

Ideal for installation in confined areas and can  
be installed either horizontally or vertically.

Smooth bore prevents blockages  
and risk of stagnating solids.

## Contents

### ① Introduction to Hep<sub>v</sub>O

Introduction to Hep<sub>v</sub>O  
Benefits  
Water seal weaknesses

### ① Hep<sub>v</sub>O Application Areas

As a replacement for water traps in waste drainage  
For branch pipe ventilation  
Recreational vehicles – such as boats, caravans, etc.  
For hot climates or where appliances are used infrequently  
Drainage from unvented boiler systems  
and condensate discharge

### ① Installation

3

4

4

5

6

6

7

8

8

9

10

### ① Testing and Maintenance

12

### ① Product Selector

13

### ① Product Detail

14

Quality, standards and approvals

14

### ① General Information

15

Further Information

15

Wavin Knowledge Centre

15

Training

15

### ① How to Videos

15

# Hygienic Self-Sealing Waste Valve

## Introduction to Hep<sub>v</sub>O

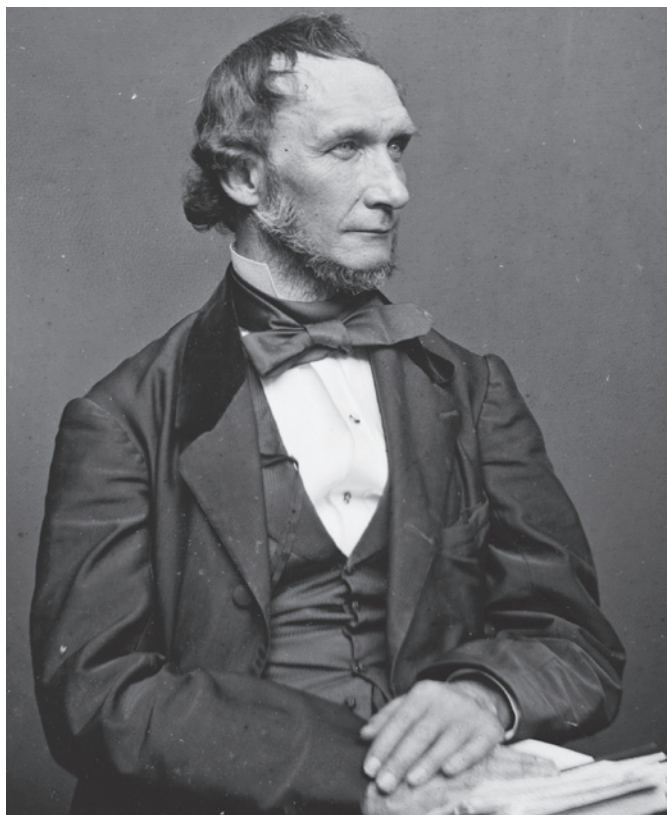

Alexander Cummings. The first plumbing water trap 1775.

## Introduction to Hep<sub>v</sub>O

The first plumbing water trap was invented by Alexander Cummings in 1775. Although there have been variations over time, it has remained largely unchanged for over 200 years... until Hep<sub>v</sub>O came along.

Hep<sub>v</sub>O does everything you'd expect from a conventional water trap – but without any of the hassles or problems that can be associated with traditional systems.

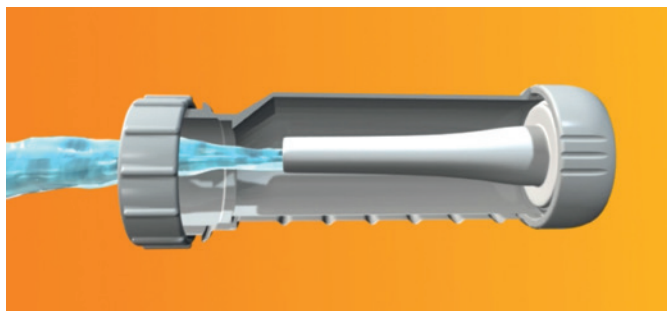

Membrane opens and closes, to prevent foul sewer odour from returning.

Sometimes water-traps can lose their seal due to evaporation, siphonage, leaking or movement. But unlike a typical trap, Hep<sub>v</sub>O uses a self-sealing, elastomeric membrane which performs exactly the same function as a water-trap – but without the risk of evaporation, siphonage or leaking due to movement.

Hep<sub>v</sub>O has been extensively tested and is resistant to common chemicals such as cleaners and detergents containing sodium hydroxide and solvents.

With millions of Hep<sub>v</sub>O's successfully installed and working in homes and businesses in Britain and around the world for over 20 years, you can have complete confidence when using Hep<sub>v</sub>O.



Rigorous testing facility.

# Hygienic Self-Sealing Waste Valve

## Introduction to Hep<sub>v</sub>O

Hep<sub>v</sub>O is a unique self-sealing waste valve that prevents the escape of foul sewer air from waste discharge systems, and actively maintains the pressure equilibrium in soil and waste installations. As a dry sealing valve, Hep<sub>v</sub>O utilises a purpose designed membrane to create an airtight seal between the living space and the drainage system. The self-sealing valve opens under the water pressure of an appliance emptying, and closes to form a tight seal after the appliance has discharged under normal atmospheric conditions.

## Benefits

The Hep<sub>v</sub>O dry self-sealing valve offers a number of benefits for both the professional installer and end user of the product. In addition, Hep<sub>v</sub>O offers considerable benefits for the system designer. See the application section of this document for further information.

- ① Hep<sub>v</sub>O actively eliminates negative pressure within the waste system by opening and allowing in fresh air until a state of equilibrium with atmosphere is reached. It subsequently closes to reseal the waste system and prevent foul air release. This means that the venting of the waste system, or the inclusion of an air admittance valve in the waste system, is no longer necessary.
- ② The Hep<sub>v</sub>O valve results in enhanced plumbing design and system efficiency. Unlike water seal traps, Hep<sub>v</sub>O is not affected by siphonage and will therefore not allow the escape of foul air into the living space from drain or sewer.
- ③ Hep<sub>v</sub>O allows discharge water to pass easily through, regardless of the volume.
- ④ Hep<sub>v</sub>O allows the placement of a greater number of appliances together on fewer discharge pipes without compromising the performance of the sanitary discharge system.
- ⑤ Hep<sub>v</sub>O operates silently and is not subject to “gurgling” noises typically associated with siphonage and indicative of a breach in the water seal barrier. Independent tests confirm that Hep<sub>v</sub>O performs silently when subjected to a range of abnormal pressures.



- ① The Hep<sub>v</sub>O valve promotes hygiene, particularly where an appliance is infrequently used. Hep<sub>v</sub>O differs from conventional traps, which can dry out or hold water which can become stagnant causing the emission of smells and enhancing bacterial growth – see Figure 1.
- ② Even when hot or cold fats are released into it, a Hep<sub>v</sub>O valve continues to perform. In comparative tests with conventional traps, a solid plug of fat forms within the trap as the fat comes into contact with the cold water held in the trap.
- ③ The Hep<sub>v</sub>O valve will perform under back pressures which are 10 times greater than those experienced in a typical soil and waste system.
- ④ The flexibility of the Hep<sub>v</sub>O valve seal prevents the accumulation of limescale.

**Figure 1. Water held in conventional traps can become stagnant**

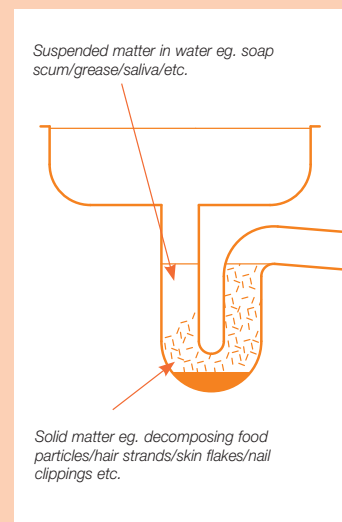

# Water Seal Weaknesses

In summary, Hep<sub>v</sub>O will not fail under any of the conditions shown below in Figure 2.

Figure 2. Ten potential reasons for trap failure

## G. Momentum

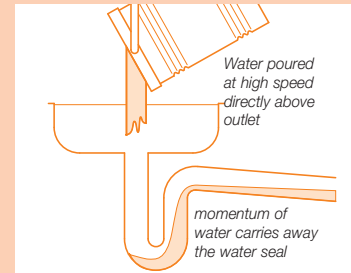

## A. Self siphonage

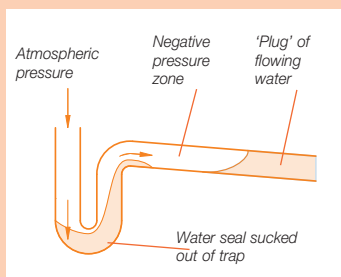

## D. Evaporation

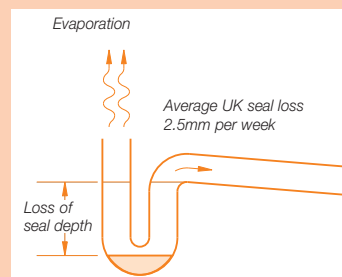

## H. Capillary action

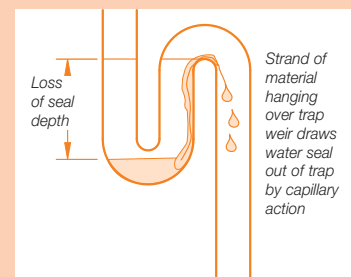

## B. Induced siphonage

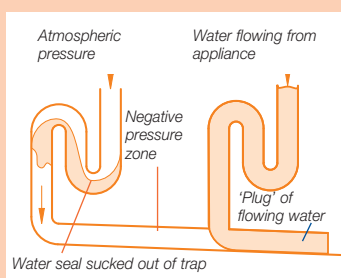

## E. Wind effect (waving out)

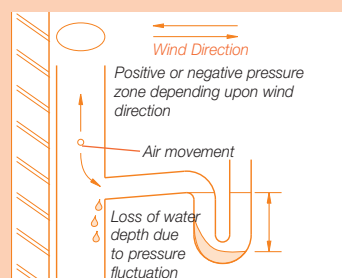

## I. Leakage

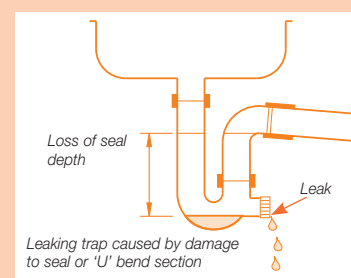

## C. Compression

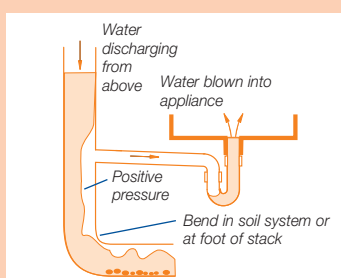

## F. Foaming

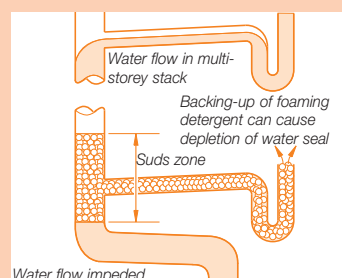

## J. Movement

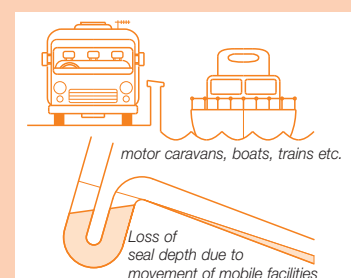

# Hygienic Self-Sealing Waste Valve

## Hep<sub>v</sub>O Application Areas

The Hep<sub>v</sub>O self-sealing waterless waste valve is suitable for use in the following application areas:

### As a replacement for water traps in waste drainage

Hep<sub>v</sub>O can be a more effective alternative for traditional waste traps on any waste appliance and on all types of sanitary systems such as primary ventilated systems (single stack) and secondary ventilated systems, stub stacks, and where appliances connect to a gully.

It's sleek design and ability to install vertically or horizontally delivers space saving opportunities, time saving (as system design can be simplified) and cost saving benefits.

#### Space Saving

- ⦿ Where required, the waste pipe can drop in a straight line from the appliance outlet which means that installation access for slimline pedestals is significantly enhanced.
- ⦿ For kitchen sinks, installing Hep<sub>v</sub>O can open up the cupboard space below the sink; particularly an issue when homeowners require integrated waste bins. See fig 3.
- ⦿ Hep<sub>v</sub>O can be installed horizontally by using the 90° adaptor, which avoids cutting the floor under baths and showers to accommodate the 'U' bend of a trap.

See WRc Technical Note TN10317 for further information.



Figure 3: Space saving capabilities under a kitchen sink

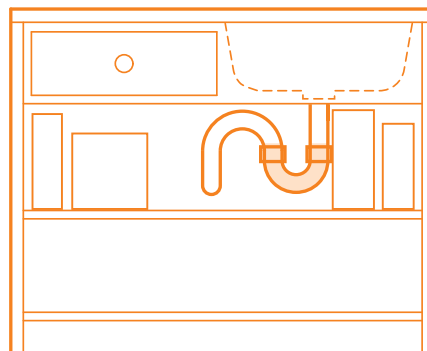

Sink cupboard with water seal trap

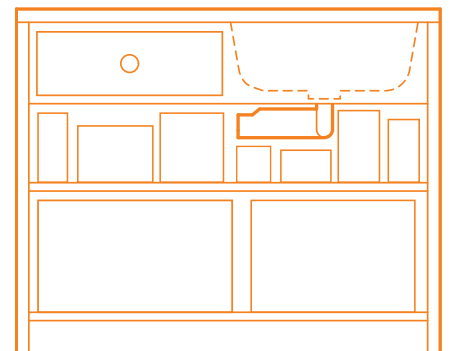

Sink cupboard with Hep<sub>v</sub>O installed horizontally

## For branch pipe ventilation

Hep<sub>v</sub>O can act as an air admittance valve, allowing air into the drainage system when negative pressure occurs. Once equilibrium is reached the valve closes. Using the valve as an air admittance tool provides cost savings, as it eliminates the need for a traditional open vent pipe or an air admittance valve to be positioned on the stack in certain circumstances; simplifies system design, **providing space and time saving benefits.**

The use of Hep<sub>v</sub>O, as it provides ventilation, can give more flexibility in pipe sizing, allowing the pipe run to be extended to 3m without needing to increase pipe size from 32mm to 40mm if going beyond 1.7m – see Figure 5.

For non-domestic situations, the use of multiple Hep<sub>v</sub>O valves allows for simpler systems with less pipework & straight runs – see Figure 4.

On completion of the installation, there is no need to perform self siphonage and induced siphonage tests for branch discharge pipes from waste appliances.

**Figure 4. Schematic view for three basins**

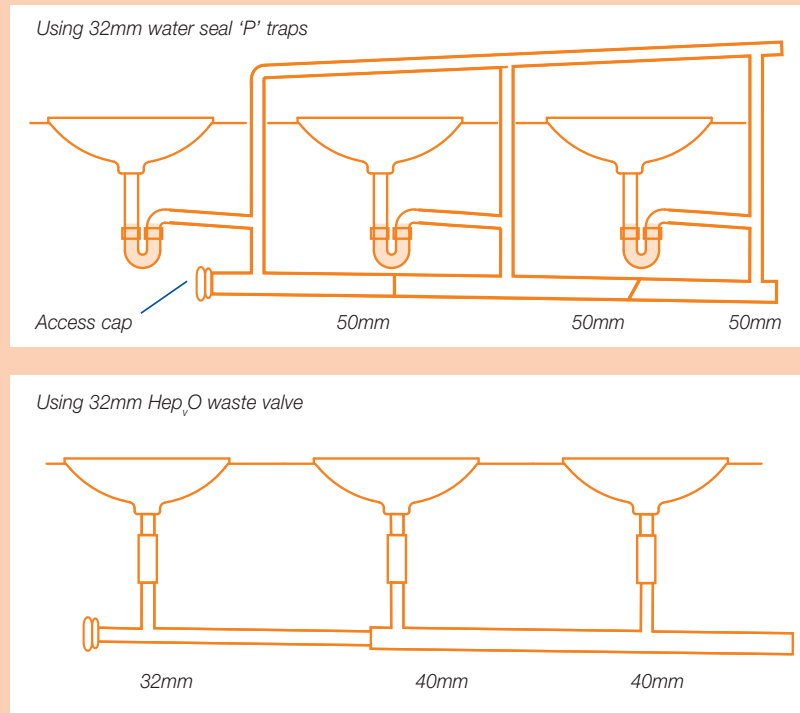

**Figure 5. Schematic view for extended pipe run**

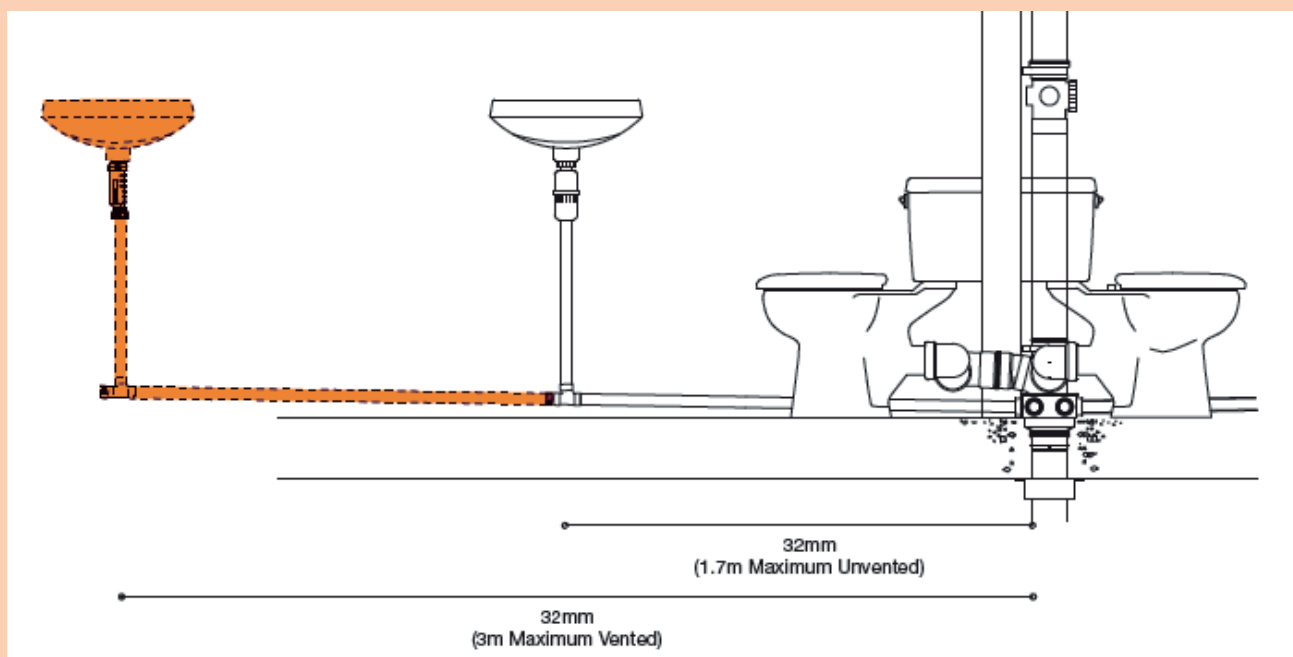

See WRc Technical Note TN10318 for further information on this application area

# Hygienic Self-Sealing Waste Valve

## Hep<sub>v</sub>O Application Areas

### Recreational vehicles – such as boats, caravans, etc.

Hep<sub>v</sub>O works perfectly in any kind of home. Because Hep<sub>v</sub>O is a waterless trap system, it performs successfully in motor homes and other moving vehicles – such as boats and caravans – where water traps can lose their seal through movement and vibration.

The use of Hep<sub>v</sub>O waterless trap also avoids a problem of the water seal freezing, and evaporation of water seal in warm weather or extended periods of non-use which would lead to odours escaping into the vehicle.

See Figures d and j on page 5 and WRc Technical Note TN10319 for further information on this application area.



Hygienic self-sealing waste valve – for when you're on the move.

### For hot climates or where appliances are used infrequently

Because Hep<sub>v</sub>O is a waterless trap system, it's great to use in situations of infrequent use, including holiday lets; guest bathrooms, park homes and recreational vehicles.

If the appliance is not used for an extended period, evaporation of water in the traditional water trap will lead to a loss of the water seal. In hot climates, with a higher risk of rapid water evaporation, this can be a particular problem, leading to odours escaping into the buildings after a relatively short period of time. Deeper water seals traps could be used, but they would require more space close to the appliance, so the Hep<sub>v</sub>O waterless trap with its slimline design, is an ideal alternative in this situation.

See Figure d on page 5 and WRc Technical Note TN10320 for further information on this application area.



Conventional waste traps can lose their seal if not used on a regular basis.



## Drainage from unvented boiler systems and condensate discharge

Hep<sub>v</sub>O can be used with an unvented hot water storage system to connect a tundish outlet pipe to a drainage stack. This stops the omission of foul air from drainage systems into premises.

Using the Hep<sub>v</sub>O tundish adaptor kit, the connection from unvented hot water discharge appliances to soil stacks is simplified in systems with a temperature and pressure valve of no more than 22mm. The kit reduces the number of fittings required, eliminating the need for a running adaptor.

The Hep<sub>v</sub>O valve may also be used in condensate piping from high efficiency boilers and air conditioning units discharging to sanitary pipework.

**Figure 6. Self-sealing valve when used with a combined temperature and pressure relief valve for unvented hot water storage system**

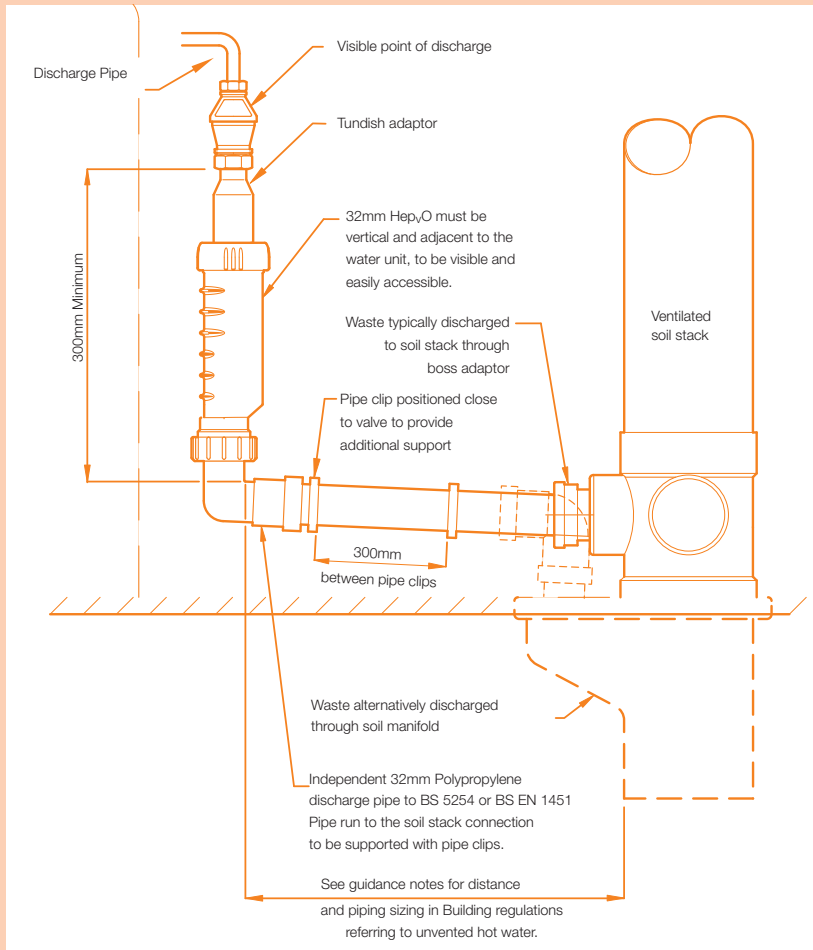

See WRc Technical Note TN10321 for further information on this application area.

### Note:

- ⊕ This application is not recommended for combi or sealed boiler systems.
- ⊕ Hep<sub>v</sub>O should not be used for uncontrolled high temperature discharges such as from pressure-only relief valves (i.e. not incorporating a temperature relief valve).



For further information on all these application areas, please refer to the WRc technical notes available on [www.wavin.co.uk](http://www.wavin.co.uk)

# Hygienic Self-Sealing Waste Valve

## Installation

Hep<sub>v</sub>O should be installed in accordance with the instructions given here.

### Orientation

When fixed horizontally to an appliance outlet or to a sloping pipe Hep<sub>v</sub>O must be installed with the ribs underneath – Figure 7. This prevents standing water and provides a continuous fall.

Figure 7.

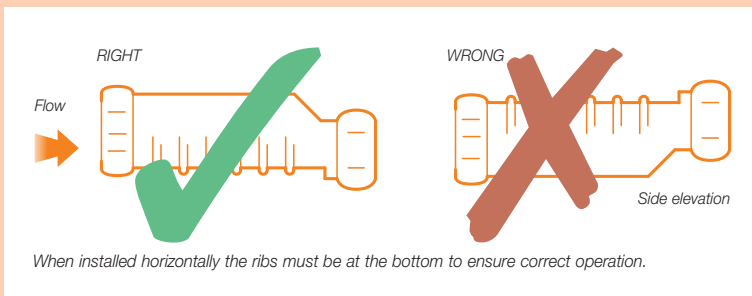

### Hep<sub>v</sub>O inlet

The inlet is provided with a screwed cap and sealing ring, designed to connect to waste fittings conforming to BS EN 274, or to a Hep<sub>v</sub>O inlet adaptor.

### To join:

Offer up the Hep<sub>v</sub>O inlet to the threaded tail of the appliance waste outlet or Hep<sub>v</sub>O knuckle or running adaptor, and tighten the threaded cap sufficiently hand-tight to provide a water-tight seal (check that the cap screws on square and does not 'cross-thread'). When the screwed cap is tight, the Hep<sub>v</sub>O body is secure.

Figure 8. Hep<sub>v</sub>O outlet connection

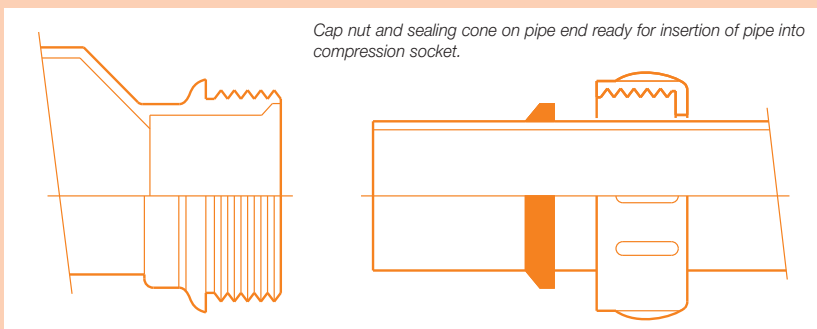

### Hep<sub>v</sub>O outlet

The outlet is provided with a universal compression connection which is designed for use with BS EN 1451-1/ BS 5254 polypropylene pipe, BS EN 1455-1 ABS pipe, BS EN 1566-1 PVC-C pipe or BS EN 1057/ BS 659 copper pipe.

### To join:

1. Cut the pipe to length, allowing for the full compression socket depth (using an appropriate pipe cutter).
2. Remove any 'swarf' from the end of the plastic pipe. Ream the copper pipe end to remove any 'burr', and file if necessary to remove any external sharp edges. Mark the socket depth on the pipe, and check that the pipe section to be jointed is free of any surface damage which may affect the joint seal.
3. Unscrew the cap from the Hep<sub>v</sub>O outlet, and slide the cap and rubber seal onto the pipe – see Figure 8.
4. Insert the pipe end fully into the socket.
5. Slide the rubber seal and screwed cap up against the face of the socket, and tighten the cap sufficiently hand-tight (check that the cap is square to the body and does not 'cross-thread').

### Note:

- ⚠ Do not use any jointing compound or sealant on the Hep<sub>v</sub>O inlet or outlet connections.

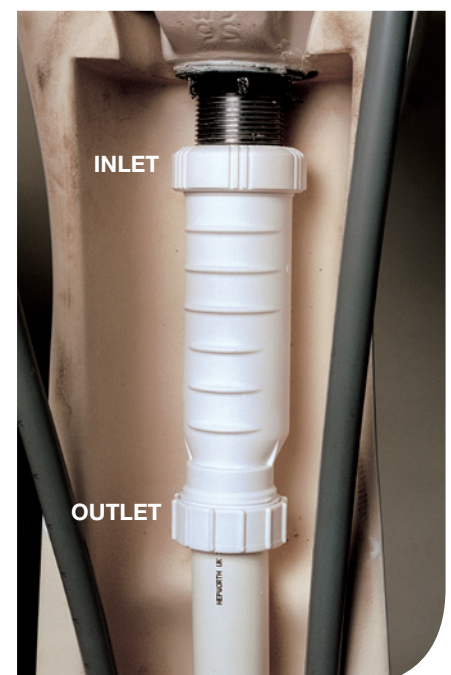

Hep<sub>v</sub>O can be used on any waste appliance. The installation arrangement will depend on the dimensional design of the appliance and site constraints. Figure 9 shows some of the mounting options for Hep<sub>v</sub>O.

If a Hep<sub>v</sub>O valve is fitted horizontally, it must be installed with the ribs underneath which ensures that waste water does not lie in the valve – see Figure 7.

Hep<sub>v</sub>O should ideally be fitted vertically. If a Hep<sub>v</sub>O valve is fitted horizontally, then a fall of around 10° is recommended so that waste water does not lie in the valve – see Figure 7.

**Waste piping**

Waste pipes should have sufficient slope to convey the likely flow, but should not be less than 18mm/metre in accordance with BS EN 12056 Part 2. When using Hep<sub>v</sub>O there is no maximum slope limitation – often a restriction applicable to single stack waste systems.

As Hep<sub>v</sub>O is unaffected by siphonage or compression, combined waste piping can be used to connect more than one appliance to the stack. Figure 10 shows how Hep<sub>v</sub>O can be used to simplify the plumbing to a typical bathroom.

Any branch discharge pipes serving appliances not fitted with Hep<sub>v</sub>O (eg. a range of WC's) should be designed and installed in accordance with BS EN 12056 Part 2. Discharge stacks should continue to be sized, and vented where appropriate, in accordance with BS EN 12056 Part 2.

**Note:** Care should be taken to ensure that the underground drainage system is not completely sealed. Natural open ventilation is required at the head of each main drain run and/or at every tenth dwelling.

**Hep<sub>v</sub>O tundish adaptor kit**

The Hep<sub>v</sub>O tundish adaptor kit should be installed as described below. Unvented hot water systems must be installed by certified and qualified installers.

1. Connect and correctly tighten the tundish adaptor spigot into the compression fitting outlet of the tundish (supplied by the manufacturer of the unvented hot water storage system).
2. Hand-tighten the screw thread connection of the tundish adaptor to the rotating captive inlet thread of the Hep<sub>v</sub>O.
3. Connect and hand-tighten the Hep<sub>v</sub>O outlet connection to the waste pipe.

**Figure 9. Hep<sub>v</sub>O mounting options**

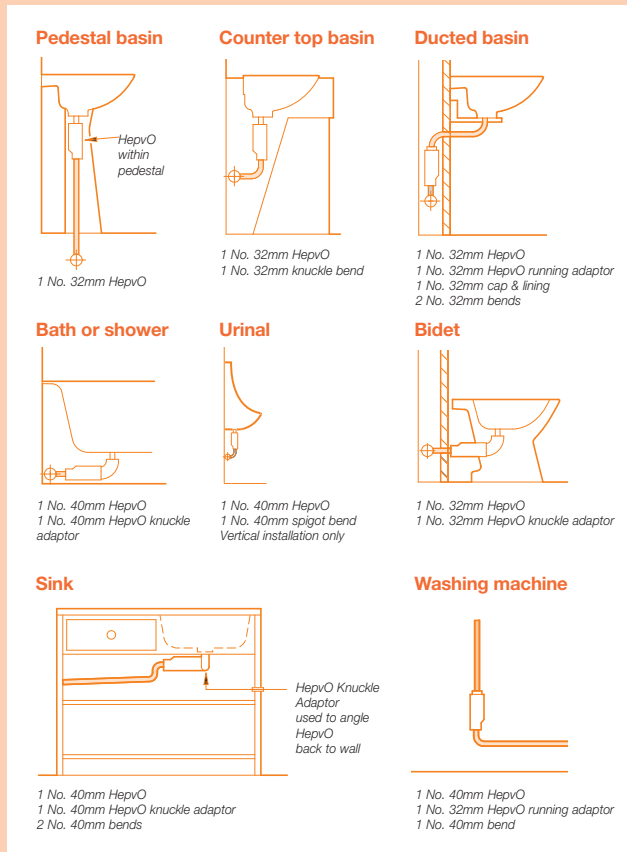

**Figure 10. Hep<sub>v</sub>O installation in a typical bathroom**

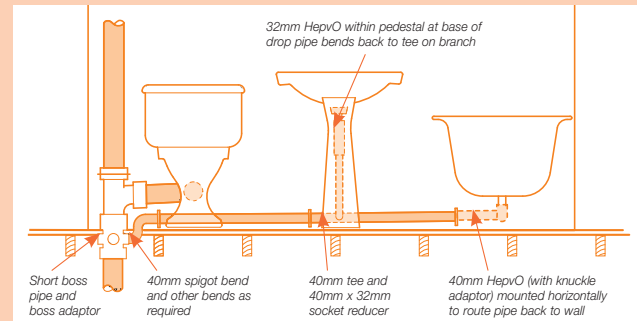

**Figure 11. Tundish adaptor kit installation on an unvented hot water storage system**

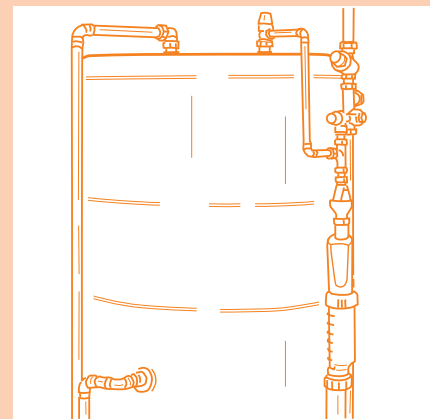

# Hygienic Self-Sealing Waste Valve

## Testing and Maintenance

Hep<sub>v</sub>O operates as illustrated in Figure 12 below. The following tests are relevant to any sanitary installation, not just to installations where Hep<sub>v</sub>O is incorporated.

### Air tests

Sanitary installations should be air tested to 38mm water gauge for at least 3 minutes, in accordance with Building Regulations Approved Document H. Installations which incorporate Hep<sub>v</sub>O can be tested in the normal manner, using standard test equipment, as shown in Figure 14. Expanding pipe stoppers are available from the Osma below ground drainage range. Smoke producing equipment should not be used when testing plastics pipework.

### Water tests

Water testing the base of a discharge stack is recommended, especially where there are no appliances on the bottom storey, and where the stack is to be concealed.

Testing is normally achieved by fixing a temporary expanding pipe stopper to the drain at the base of the stack, and filling the stack with water up to the flood level of the lowest sanitary appliance (providing that the test pressure does not exceed 6 meters water gauge for soil and waste products and 4 meters water gauge for drainage products).

When performing a water test, it is recommended that the expanding pipe stopper is provided with a temporary strut (to prevent blow-out), and fitted with a drain valve.

### Performance tests

Sanitary installations should be tested at simultaneous design flow conditions in accordance with BS EN 12056 Part 2. Tests for self-siphonage and induced siphonage in branch discharge pipes where Hep<sub>v</sub>O is fitted to each appliance are unnecessary.

Other branch pipes and discharge stacks should be tested in accordance with BS EN 12056 Part 2.

### Blockages

If a pipe blockage occurs downstream of Hep<sub>v</sub>O we recommend temporarily removing the Hep<sub>v</sub>O valve before rodding the pipeline. If the Hep<sub>v</sub>O is rodded there is the possibility that damage to the internal components will occur.

### Cleaning

The following should be noted prior to cleaning an installation using an Hep<sub>v</sub>O valve:

- ⊕ Strong acids, e.g. cleaners containing high concentrations of sulphuric acid, must not be used on Hep<sub>v</sub>O.
- ⊕ When rodding or flushing with a sulphuric acid solution, the valve must be removed before the operation.
- ⊕ Hep<sub>v</sub>O is resistant to standard caustic based drain cleaners and all cleaning agents must be flushed through immediately after use.

Figure 12. Operation of Hep<sub>v</sub>O

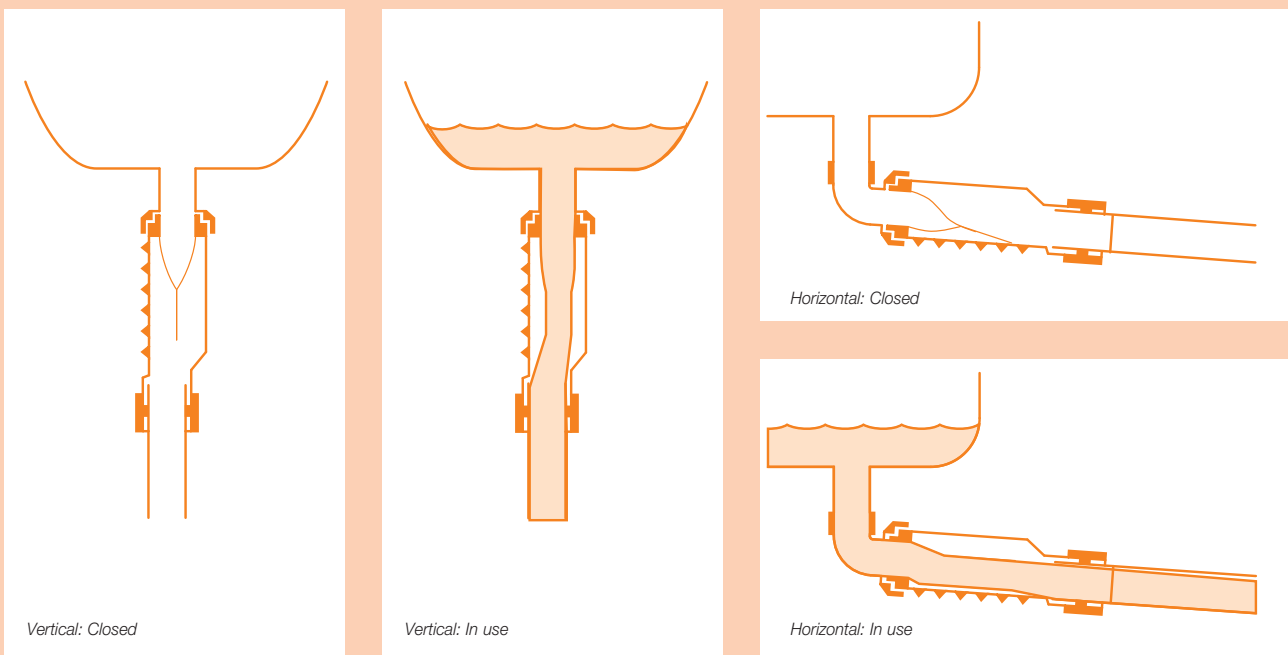

# Hygienic Self-Sealing Waste Valve

## Product Selector

### Hep<sub>v</sub>O Hygienic Self-Sealing Waste Valve

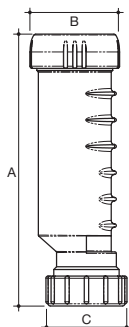

#### Hep<sub>v</sub>O Valve

Material: Polypropylene

Nominal Size (mm)	Part Number	Colour Option	Dimensions (mm)		
			A	B	C
32	BV1 ♡	○	188	61	55
40	CV1 ♡	○	188	68	62

### Hep<sub>v</sub>O Knuckle Adaptor

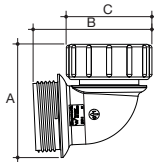

#### Hep<sub>v</sub>O 87.5° Knuckle Adaptor

- For Horizontal applications
- Material: Polypropylene

Nominal Size (mm)	Part Number	Colour Option	Dimensions (mm)		
			A	B	C
32	BV11 ♡	○	66	70	50
40	CV11 ♡	○	70	74	56

### Hep<sub>v</sub>O Running Adaptor

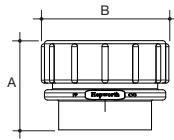

#### Hep<sub>v</sub>O Running Adaptor

- For installing Hep<sub>v</sub>O in a pipe run
- Material: Polypropylene

Nominal Size (mm)	Part Number	Colour Option	Dimensions (mm)	
			A	B
32	BV3 ♡	○	43	55
40	CV3 ♡	○	43	62

### Hep<sub>v</sub>O Tundish Adaptor

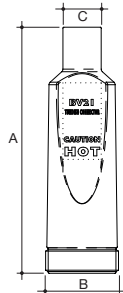

#### Hep<sub>v</sub>O Tundish Adaptor Kit

- Comprises a 32mm Hep<sub>v</sub>O valve and tundish adapter.
  - Dimensions given for the tundish (see BV1 for Hep<sub>v</sub>O valve dimensions)
  - Total length of valve with tundish installed is 320mm
- Material: Polypropylene

Nominal Size (mm)	Part Number	Colour Option	Dimensions (mm)		
			A	B	C
32	BV1/21 ♡	○	142	22	15

For installation tips see:



# Hygienic Self-Sealing Waste Valve

## Product Details

The Hep<sub>v</sub>O valve and knuckle adaptors are available in sizes 32mm and 40mm. The Hep<sub>v</sub>O tundish adaptor kit comprises a 32mm Hep<sub>v</sub>O valve and tundish adaptor. A 87.5° knuckle adaptor should be used with the Hep<sub>v</sub>O valve for horizontal applications, and a running adaptor when installed the Hep<sub>v</sub>O in a pipe run. All items are manufactured from white polypropylene. Dimensional data for the Hep<sub>v</sub>O is shown in Figure 13 below.

### Hep<sub>v</sub>O dimensional data

Figure 13. Principle dimensions (mm)

SIZE	C	E	L	W	Z	H
32mm	8	171	208	211	40	70
40mm	5	171	208	213	40	73

#### Notes:

- ⦿ Dimensions are nominal and may vary slightly due to compression of the rubber seals.
- ⦿ When fixed to a pipe, it is recommended that Hep<sub>v</sub>O should remain accessible.

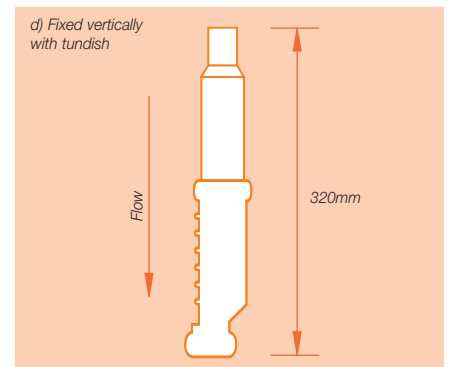
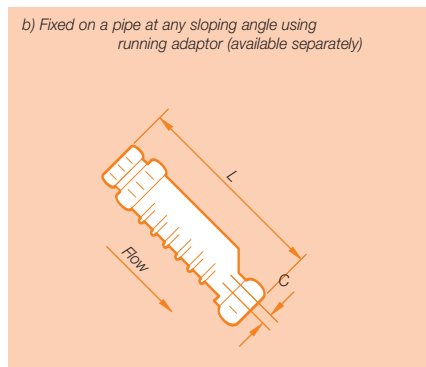
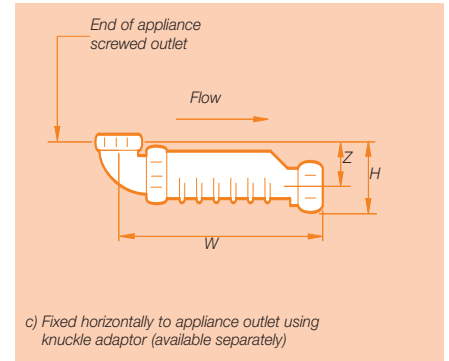
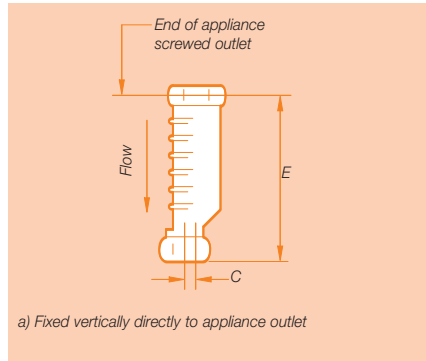

## Quality, standards and approvals

All OSMA branded products are manufactured under a quality management system which is approved to BS EN ISO 9001.

All Wavin manufacturing sites operate Environmental Management Systems which comply with the requirements of, and are certified to, BS EN ISO 14001.

The use of Hep<sub>v</sub>O, when installed in accordance with manufacturers recommendations, will ensure that installations comply with the requirements of BS EN 12056 Part 2 Code of Practice for Sanitary Pipework, and Document H of the Building Regulations 2002 'Drainage and Waste Disposal, with respect to seal integrity.

Hep<sub>v</sub>O functions without the use of water and complies with all other relevant functional requirements of BS EN 274: Specification for Plastics Waste Traps.

Hep<sub>v</sub>O also complies with BS EN 15749-1 2004 Ships and Marine Technology – drainage systems on ships and marine structures.

Hep<sub>v</sub>O is kitemarked to ATS 5200-047:2005 (KM 618560): Technical Specification for plumbing and drainage products – Self-sealing devices



ATS 5200-047:2005

Test results indicate that the Hep<sub>v</sub>O valve has a life expectancy at least equivalent to current water sealed traps.

## General Information

### Further Information

For more information on specific application areas, please refer to the WRc information leaflets. Available to download from [www.wavin.co.uk](http://www.wavin.co.uk)



### Wavin Knowledge Centre

Keep ahead of breaking news with a fresh and insightful look into the construction industry. Our aim is to keep you informed and up to date with the latest how-to guides, regulations, innovation and more. Visit [blog.wavin.co.uk](http://blog.wavin.co.uk)

### Training

Develop your knowledge and keep up to date with our range of CPD presentations and online e-learning modules.

To see what CPD courses are available and to book, visit [cpd.wavin.co.uk](http://cpd.wavin.co.uk)

To see what online training modules are available, visit [myportal.wavin.co.uk](http://myportal.wavin.co.uk)



## 'How to' videos

To accompany this brochure, there is a set of installation 'how to' Osma Hep<sub>v</sub>O videos. They can be viewed at [www.youtube.com/WavinUK](http://www.youtube.com/WavinUK) under the Osma Hep<sub>v</sub>O playlist.

- 🕒 Waterless Trap System Overview
- 🕒 Fitting pedestal basin waste in limited space situations
- 🕒 Installing under a sink where space is at a premium
- 🕒 Fitting a bath waste where depth is limited

In addition, you can find other Wavin video's on the channel also, for Osma Soil and Waste, Osma Rainwater, Hep<sub>2</sub>O Plumbing and Underfloor heating and more.



## Discover our broad portfolio at [www.wavin.co.uk](http://www.wavin.co.uk)

Hot & Cold Water

Foul Water

Gas & Water Mains

Indoor Climate

Storm Water

Geotextiles

Soil & Waste

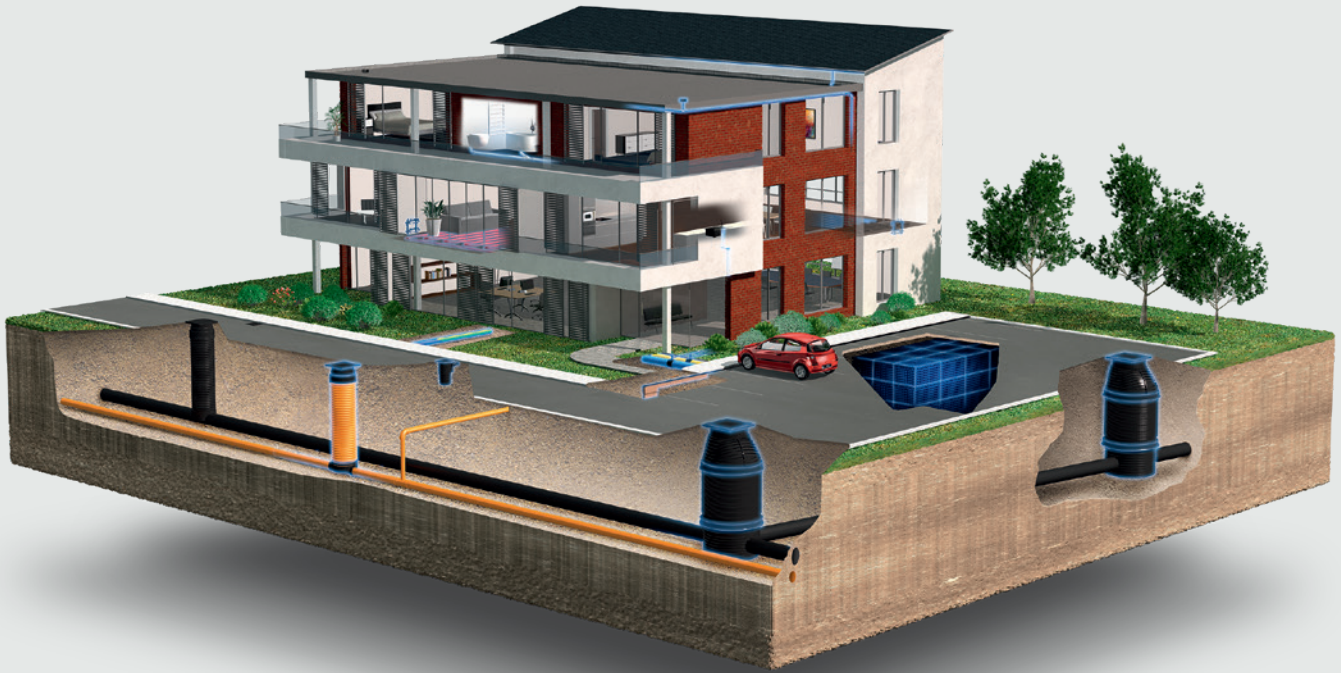

Wavin is part of Orbia, a community of companies working together to tackle some of the world's most complex challenges. We are bound by a common purpose: To Advance Life Around the World.



**Wavin Limited** | Registered Office | Edlington Lane | Doncaster | DN12 1BY  
Tel. 0800 038 0088 | [www.wavin.co.uk](http://www.wavin.co.uk) | [info@wavin.co.uk](mailto:info@wavin.co.uk)

Wavin operates a programme of continuous product development, and therefore reserves the right to modify or amend the specification of their products without notice. All information in this publication is given in good faith, and believed to be correct at the time of going to press. However, no responsibility can be accepted for any errors, omissions or incorrect assumptions.

© 2021 Wavin Wavin reserves the right to make alterations without prior notice. Due to continuous product development, changes in technical specifications may change. Installation must comply with the installation instructions.